

rev13

ORDER FORM

Electric Attachable Handcycle for Wheelchairs



Registered Design N.: 40202000002686
Patent N.: 102018000010144; PCT/IB2021/050397;
EP21183365; 102021000003680;



Suitable with all Wheelchair models

EASY TO CONNECT

DATE

USER

RESPONSIBLE

DEALER

MAIL

PHONE

Select model

PND-P3-STD

ELECTRIC PROPULSOR
PANDHORA EP3 STANDARD (500W/36V 13Ah)

- Wheel 14"
- LCD colour display
- Integrated stand
- 1 Electro-hydraulic disc brake
- Led light
- Reverse
- Luggage hook



Autonomy 40Km
Charging Time ≈ 3h

PND-P3-PLS

ELECTRIC PROPULSOR
PANDHORA EP3 PLUS (1000W/48V 16Ah)

- Wheel 14"
- LCD colour display
- Integrated stand
- Double electro-hydraulic disc brake frictionable
- Led light
- Reverse
- Cruise control
- Static regenerative brake function
- Luggage hook



Autonomy 50Km
Charging Time ≈ 3h 30'

PND-P3-OFF

ELECTRIC PROPULSOR
PANDHORA EP3 OFF ROAD (1000W/48V 16Ah)

- Wheel 14,5" FAT tessellated tubeless anti-drilling
- LCD colour display
- Integrated stand
- Double electro-hydraulic disc brake frictionable
- Die cast front light with protective grille
- Reverse
- Cruise control
- Static regenerative brake function
- Double mirror
- Storage bag
- Luggage hook



Autonomy 50Km
Charging Time ≈ 3h 30'

Select model

PND-P3-SMT

ELECTRIC PROPULSOR
PANDHORA EP3 SMART (500W/36V 13Ah)

- Wheel 12"
- LCD colour display
- Integrated stand
- 1 Electro-hydraulic disc brake
- Led light
- Reverse
- Luggage hook



Autonomy 40Km
Charging Time ≈ 3h

PND-P3-END

ELECTRIC PROPULSOR
PANDHORA EP3 ENDURO (1000W/48V 16Ah)

- Wheel 16"
- LCD colour display
- Integrated stand
- Double electro-hydraulic disc brake frictionable
- Die cast front light with protective grille
- Reverse
- Cruise control
- Static regenerative brake function
- Mirror
- Luggage hook



Autonomy 50Km
Charging Time ≈ 3h 30'

FRAME

SETUP

L > 36cm (14")

L ≤ 36cm (14")

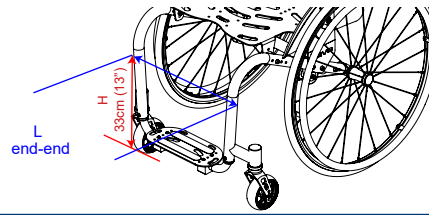

Shaft: L

Shaft: S

FIXED FOOTREST WITH STRAIGHT FRAME

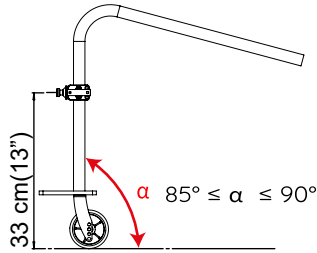

Connection: A

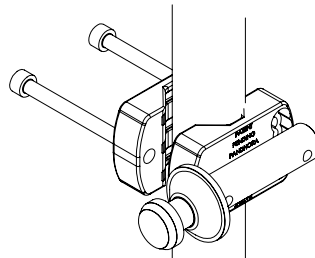

NB: Fixed mounting with 2 screws

Note: In the absence of parallelism the best compromise is the tip pointing downwards.

Stand type: Normal
Handlebar depth: 15cm; 5.9"
Arms size: S
Depth adjusters size: S

Kit supplied by Pandhora:
Universal clamps • Conical pin • 2 Screws M6x60 ISO 4762

FIXED FOOTREST WITH INCLINED FRAME

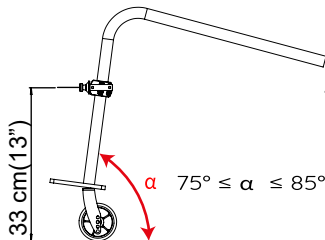

Connection: B

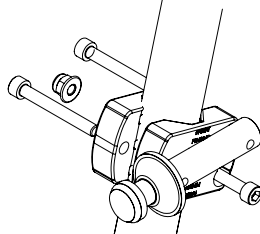

NB: Fixed mounting with 3 screws

Note: In the absence of parallelism the best compromise is the tip pointing downwards.

Stand type: Normal
Handlebar depth: 17cm; 6.7"
Arms size: M
Depth adjusters size: L

Kit supplied by Pandhora:
Universal clamps • Conical pin
• 3 Screws M6x60 ISO 4762 • Nut M6 ISO 7043

REMOVABLE FOOTREST

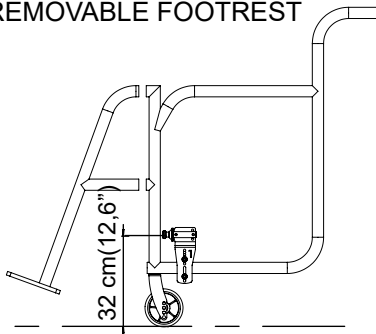

Connection: C

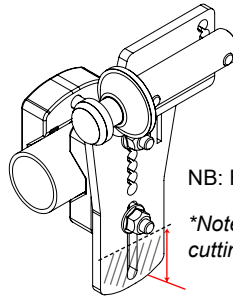

Recommended: Conical pin located outside

NB: Fixed mounting with 2 screws

*Note¹: Maximum cutting distance 3,5 cm

Note: In the absence of parallelism the best compromise is the tip pointing downwards.

Stand type: Retractable
Handlebar depth: 17cm; 6.7"
Arms size: L
Depth adjusters size: L

Kit supplied by Pandhora:
Universal clamps • Conical pin • 2 Screws M6x60 ISO 4762
• Plate N.1 • 2 Screws M6x20 ISO 7380 • 2 Nuts M6 ISO 7043

FIXED FOOTREST WITH CLOSED FRAME

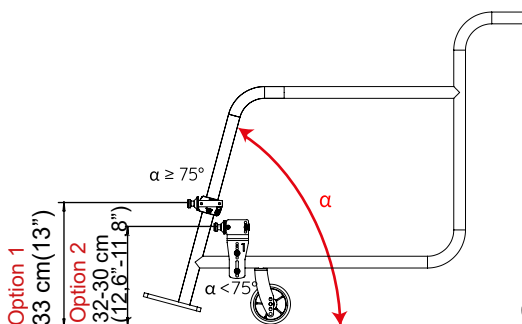

Option 1 - Connection: B

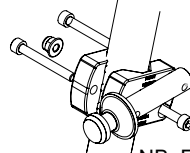

NB: Fixed mounting with 3 screws

Note: In the absence of parallelism the best compromise is the tip pointing downwards.

Stand type: Retractable
Handlebar depth: 17cm; 6.7"
Arms size: L
Depth adjusters size: L

Option 2 - Connection: C

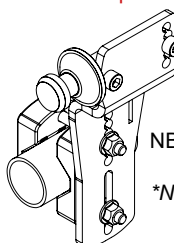

Recommended: Conical pin located inside

NB: Fixed mounting with 2 screws

*Note¹

Kit supplied by Pandhora:
Universal clamps • Conical pin • 2 Screws M6x60 ISO 4762
• Plate N.1 • 2 Screws M6x20 ISO 7380 • 2 Nuts M6 ISO 7043

Important: 1) Where the Nut M6 ISO 7043 is not present, fix the Screws M6x60 ISO 4762 using Threadlocker Medium strength.
2) Fix all the Screws using Torque wrench 12Nm

CONFIGURATION CLASSIC HANDLEBAR

STANDARD

EP3 STANDARD

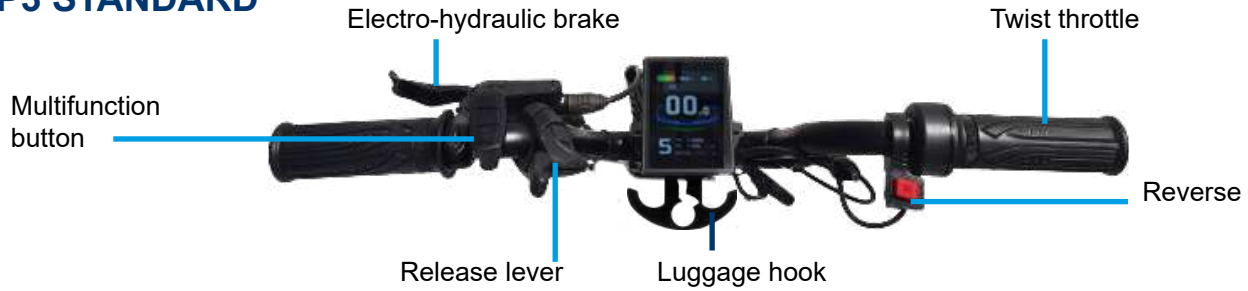

EP3 PLUS



EP3 OFF ROAD

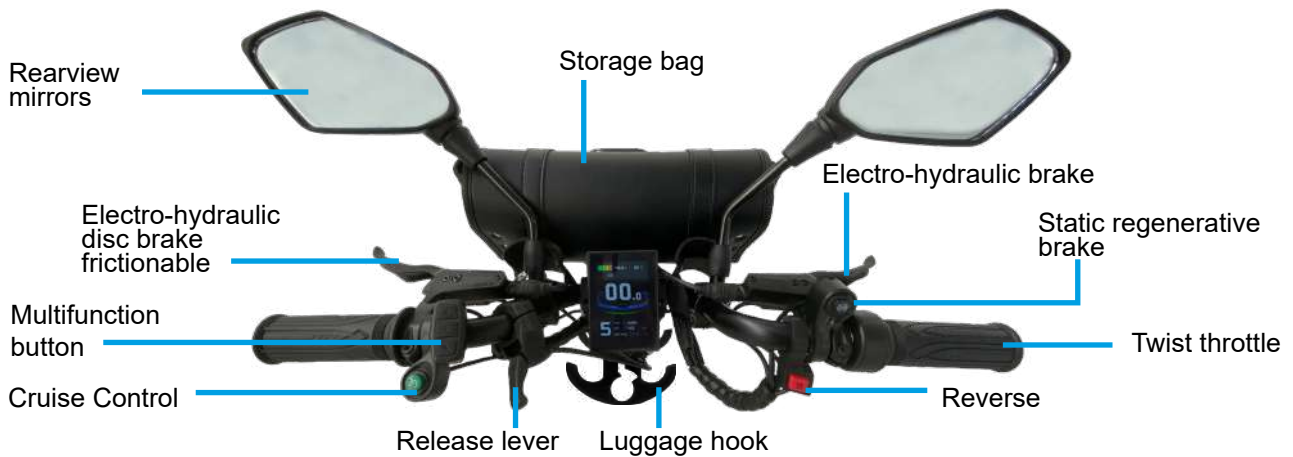

CONFIGURATION TETRA START&STOP HANDLEBAR

OPTIONAL

*Can be installed on any EP3 model



CONFIGURATION CLASSIC HANDLEBAR

STANDARD

EP3 SMART

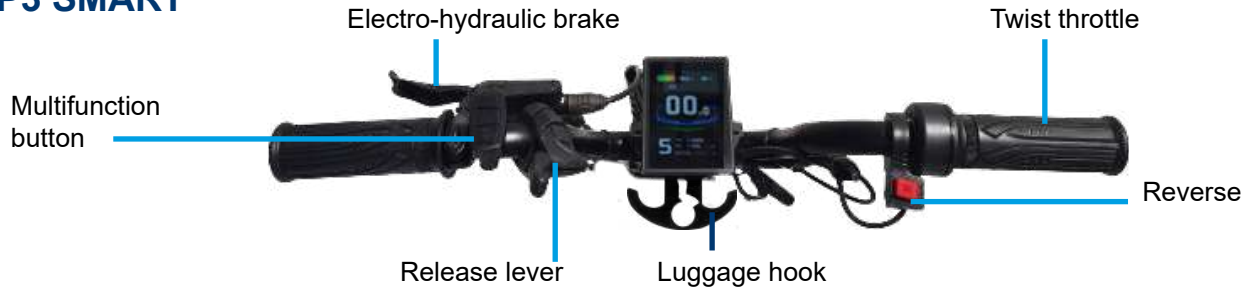

EP3 ENDURO

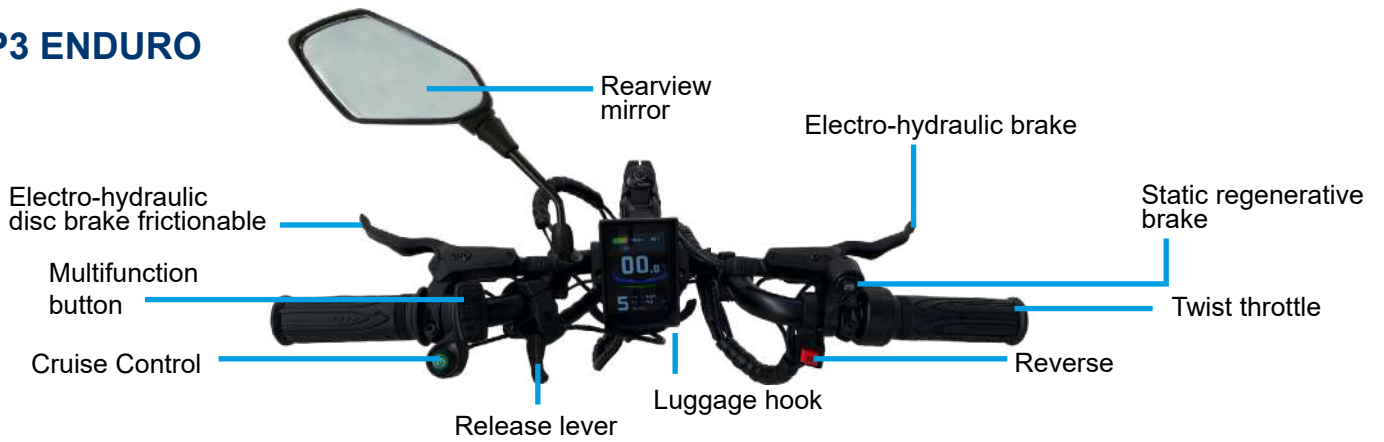

CUSTOM CONFIGURATION CLASSIC HANDLEBAR

OPTIONAL

Electro-hydraulic brake
(only for Ep3 Standard)



Rh Lh

Release lever



Rh Lh

Twist throttle



Thumb throttle vertical



Rh Lh

Thumb throttle horizontal



BUTTON CONTROLS (max 3 for each side)

Reverse



Rh Lh

Multifunction



Rh Lh

Static regenerative brake



Rh Lh

Cruise Control



Rh Lh

CUSTOM CONFIGURATION TETRA START&STOP HANDLEBAR

OPTIONAL

Reverse



Rh Lh

Static regenerative brake



Rh Lh

Multifunction



Rh Lh

FRAME COLOR

BLACK (Standard)



BLUE (Optional)



PURPLE (Optional)



RAL (OPTIONAL)

Indicate the RAL code of your favorite color

ACCESSORIES

OPTIONAL

Rearview mirrors



Rh Lh

Storage bag



Bell



Rh Lh

NOTES

*Other accessories, other powers and wheel dimensions available on request.